



UGZ20DCF THRU UGZ20JCF

ULTRAFAST EFFICIENT RECTIFIERS

Reverse Voltage - 200 to 600 Volts

Forward Current - 20 Amperes

ITO-220AB

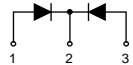
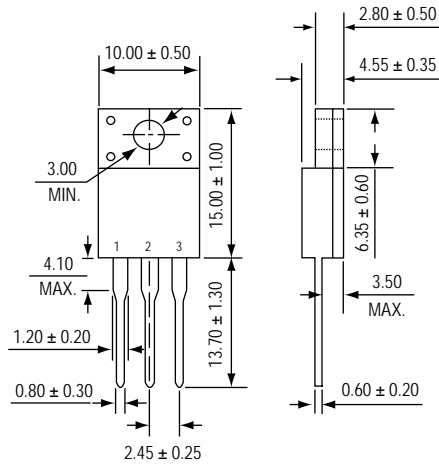

*Dimensions in millimeters

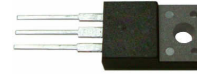

FEATURES

- * Glass passivated cavity-free junction
- * Compliance to RoHS product
- * Ultrafast recovery time for high efficiency
- * Low forward voltage, high current capability
- * Low leakage current
- * High surge current capability
- * Plastic Material-UL Recognition Flammability Classification 94V-0

MECHANICAL DATA

Case : JEDEC ITO-220AB molded plastic body

Terminals : Plated Leads, solderable per MIL-STD-750, Method 2026

Polarity : Molded on body

Mounting Position : Any

MAXIMUM RATINGS AND ELECTRICAL CHARACTERISTICS

Ratings at 25 °C ambient temperature unless otherwise specified.	SYMBOLS	UGZ20DCF	UGZ20GCF	UGZ20JCF	UNITS
Maximum repetitive peak reverse voltage	VRRM	200	400	600	Volts
Working peak reverse voltage	VRWM	200	400	600	
Maximum RMS voltage	VRMS	140	280	420	
Maximum DC blocking voltage	VDC	200	400	600	
Maximum average forward rectified current See Fig. 1	I (AV)	20			Amps
Peak forward surge current 8.3ms single half sine-wave superimposed on rated load (JEDEC Method)	IFSM	150	125		Amps
Maximum instantaneous forward voltage IF = 10 A, TA=25	VF	1.10	1.30	1.70	Volts
Maximum DC reverse current at rated DC blocking voltage @TA=25	IR	5			uA
Maximum reverse recovery time (NOTE 3)	trr	35			nS
Typical junction capacitance (Note 1)	CJ	98			pF
Operating temperature range	TJ	-50 to +150			
Storage temperature range	TSTG	-55 to +150			

Note : 1. Measured at 1.0MHz and applied reverse voltage of 4.0V.
2. Thermal resistance junction to case.
3. Reverse recovery test condition : IF 0.5A, IR=1.0A, Irr=0.25A

RATINGS AND CHARACTERISTIC CURVES UGZ20DCF THRU UGZ20JCF

FIG.1 - FORWARD CURRENT DERATING CURVE

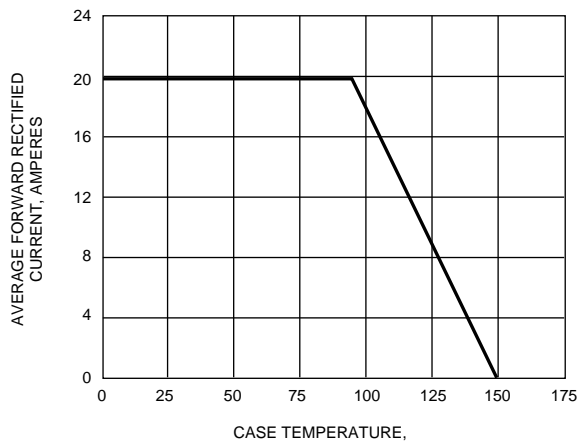

FIG.2 - MAXIMUM NON-REPETITIVE PEAK FORWARD SURGE CURRENT

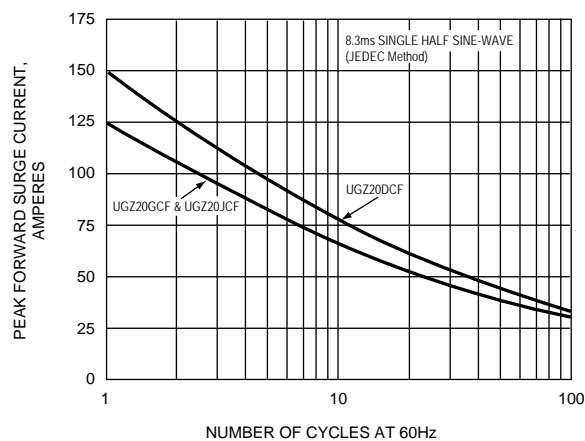

FIG.3 - TYPICAL INSTANTANEOUS FORWARD CHARACTERISTICS

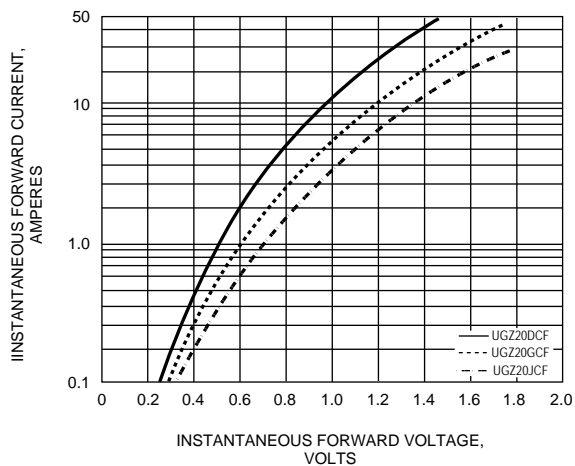

FIG.4 - TYPICAL REVERSE CHARACTERISTICS

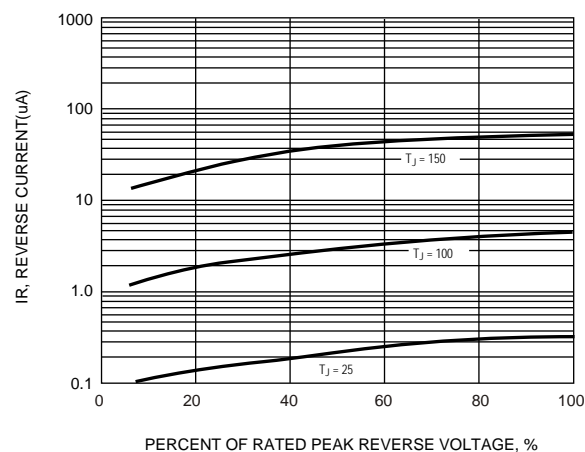

FIG.5 - TYPICAL JUNCTION CAPACITANCE

