



# UGZ16DCF THRU UGZ16JCF

## ULTRAFAST EFFICIENT RECTIFIERS

Reverse Voltage - 200 to 600 Volts

Forward Current - 16 Amperes

### ITO-220AB

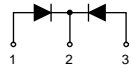
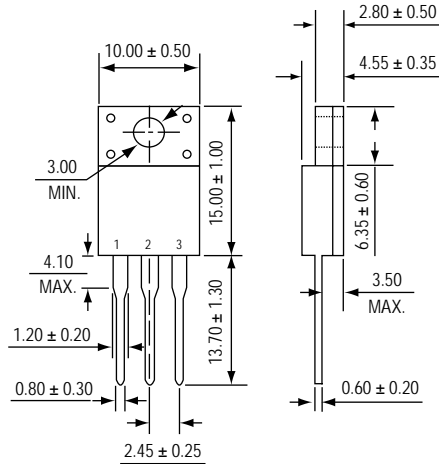

\*Dimensions in millimeters

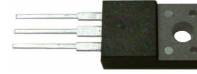

### FEATURES

- \* Glass passivated cavity-free junction
- \* Compliance to RoHS product
- \* Ultrafast recovery time for high efficiency
- \* Low forward voltage, high current capability
- \* Low leakage current
- \* High surge current capability
- \* Plastic Material-UL Recognition Flammability Classification 94V-0

### MECHANICAL DATA

**Case :** JEDEC ITO-220AB molded plastic body

**Terminals :** Plated Leads, solderable per MIL-STD-750, Method 2026

**Polarity :** Molded on body

**Mounting Position :** Any

### MAXIMUM RATINGS AND ELECTRICAL CHARACTERISTICS

Ratings at 25 °C ambient temperature unless otherwise specified.	SYMBOLS	UGZ16DCF	UGZ16GCF	UGZ16JCF	UNITS
Maximum repetitive peak reverse voltage	VRRM	200	400	600	Volts
Working peak reverse voltage	VRWM	200	400	600	
Maximum RMS voltage	VRMS	140	280	420	
Maximum DC blocking voltage	VDC	200	400	600	
Maximum average forward rectified current See Fig. 1	I (AV)	16			Amps
Peak forward surge current 8.3ms single half sine-wave superimposed on rated load (JEDEC Method)	IFSM	150	125		Amps
Maximum instantaneous forward voltage IF = 8 A, TA=25	VF	1.10	1.30	1.70	Volts
Maximum DC reverse current at rated DC blocking voltage @TA=25	IR	5			uA
Maximum reverse recovery time (NOTE 3)	trr	35			nS
Typical junction capacitance (Note 1)	CJ	85			pF
Typical thermal resistance (Note 2)	R JC	3.2			/ W
Operating temperature range	TJ	-50 to +150			
Storage temperature range	TSTG	-55 to +150			

Note : 1. Measured at 1.0MHz and applied reverse voltage of 4.0V.  
2. Thermal resistance junction to case.  
3. Reverse recovery test condition : IF 0.5A, IR=1.0A, Irr=0.25A

# RATINGS AND CHARACTERISTIC CURVES UGZ16DCF THRU UGZ16JCF

FIG. 1 - FORWARD CURRENT DERATING CURVE

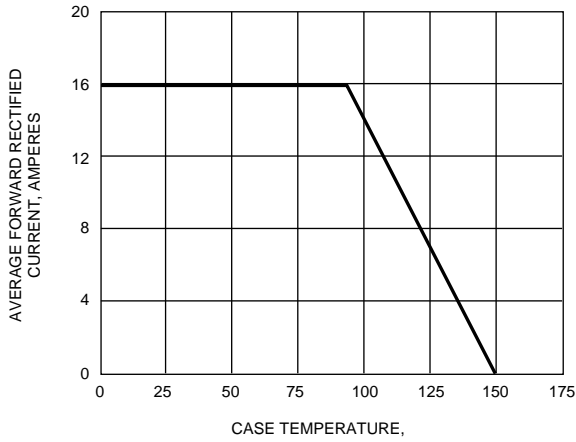

FIG. 2 - MAXIMUM NON-REPETITIVE PEAK FORWARD SURGE CURRENT

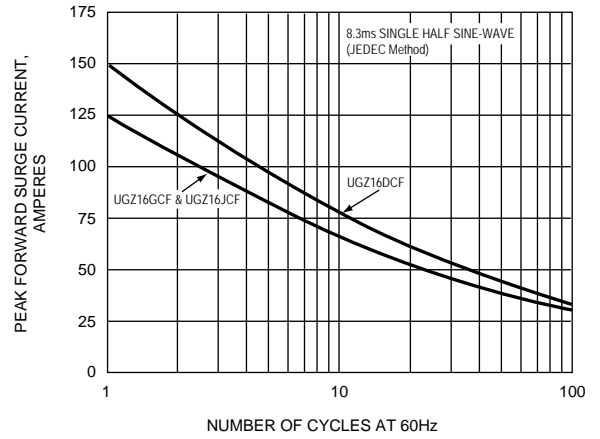

FIG. 3 - TYPICAL INSTANTANEOUS FORWARD CHARACTERISTICS

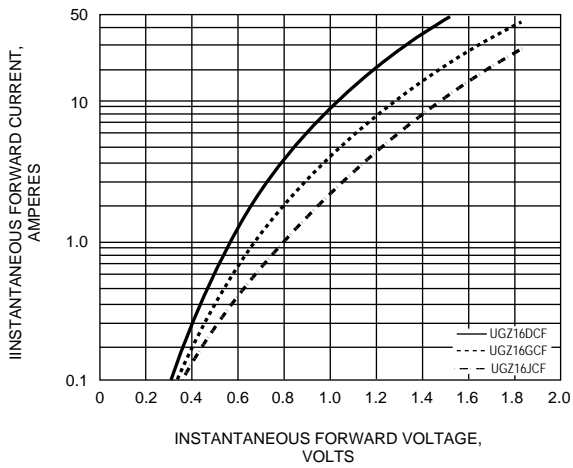

FIG. 4 - TYPICAL REVERSE CHARACTERISTICS

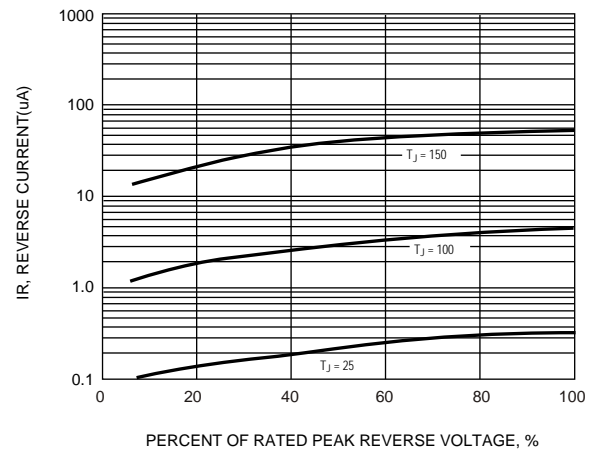

FIG. 5 - TYPICAL JUNCTION CAPACITANCE

